

Air Displacement Vent Units

Type QSH · ISH



TROX[®] TECHNIK

TROX GmbH
Heinrich-Trox-Platz
D-47504 Neukirchen-Vluyn

Telephone +49/28 45/2 02-0
Telefax +49/28 45/2 02-2 65
e-mail trox@trox.de
www.troxtechnik.com

Contents · Description

Description	2
Construction · Dimensions	4
Materials	4
Installation	5
Nomenclature	6
Technical Data	7
Order Details	8

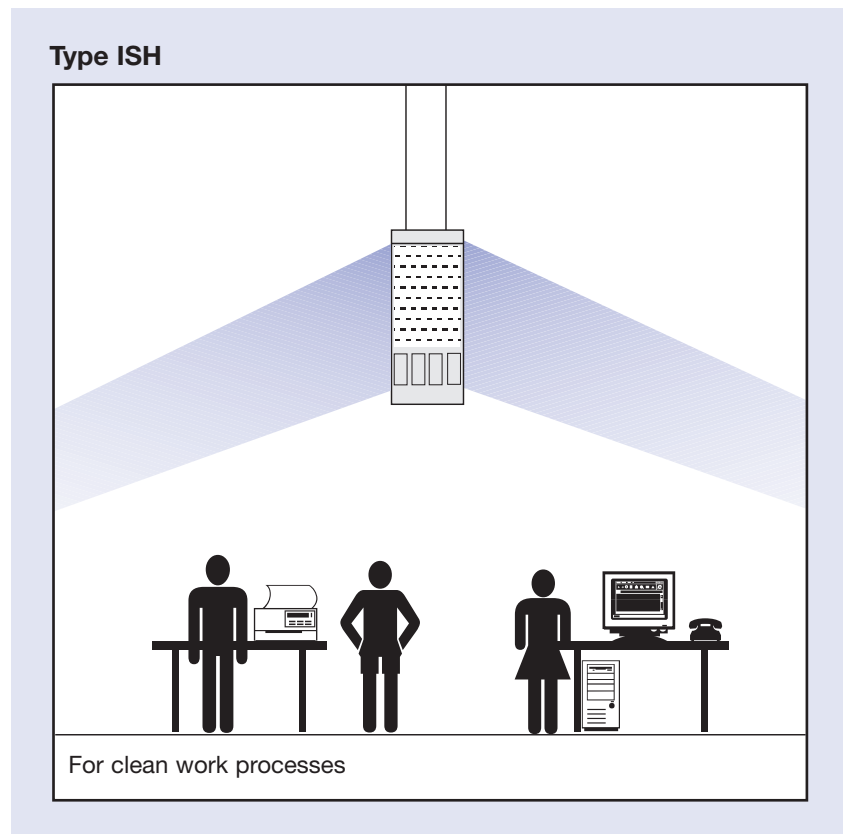
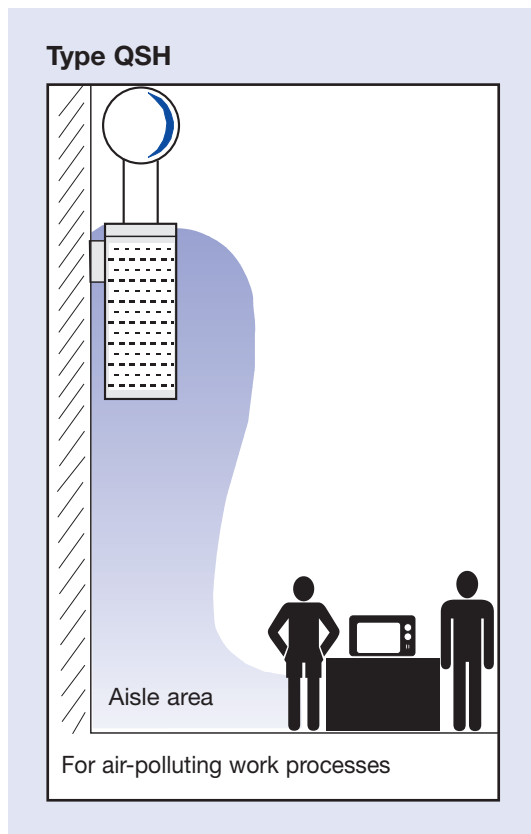

Description

Air displacement vent units types QSH and ISH are mainly used in industrial areas with heights of 3.5 to 10 m, installation can be freely suspended or fixed to columns or walls.

In rooms or halls with changing thermal loads the supply air temperature can provide either heating or cooling functions and the air itself can be discharged horizontally or vertically.

Air polluting work processes suggest the use of the type QSH since in the cooling mode it provides a bell-shaped low turbulence air distribution.

The type ISH can be used for industrial applications without this restriction. The high discharge momentum, resulting from the rectangular openings in the outer casing, ensures a wider throw of the air jet so that a larger area can be provided with fresh air.

The recommended supply air temperature differential for both types is in the range of -8K to +12K.

When cooling (discharge of chilled air) the supply air has to be discharged horizontally in order to comply with the comfort criteria. When heating (discharge of warm air) the supply air has to be discharged vertically downwards, otherwise it would not reach the occupied zone due to thermal buoyancy effects.

The air control disc can be adjusted either manually using a chain pull or Bowden cable, electrically with an actuator or by a self powered thermal actuator.

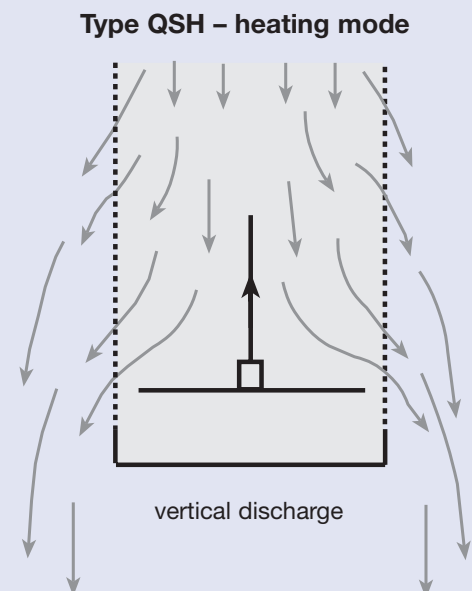
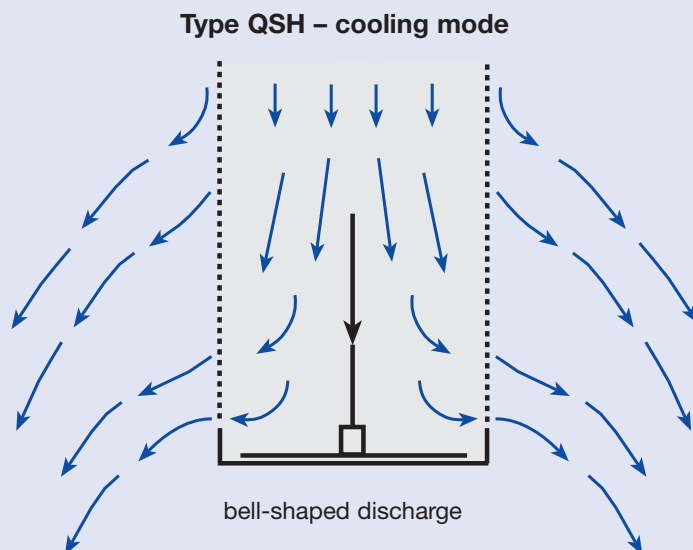
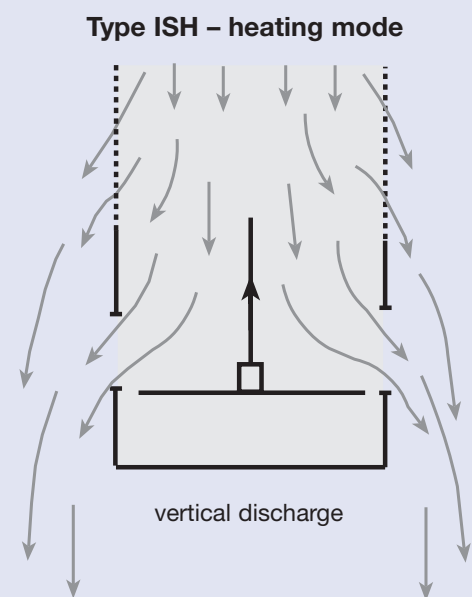
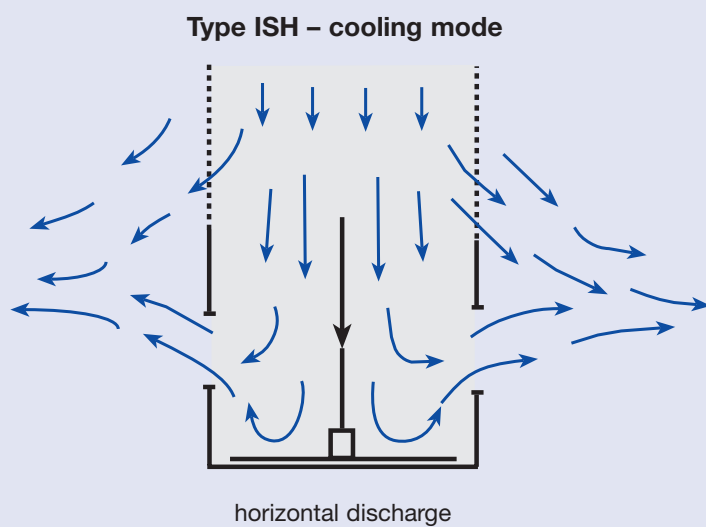

Construction · Dimensions · Materials

Construction

Air displacement vent units types QSH and ISH are available in four sizes. They comprise a perforated cylinder with a formed circular spigot, an internal air control disc and a solid base plate.

The adjustment of the air discharge direction can optionally either be by means of manual adjustment with a chain (QSH/ISH) or Bowden cable (QSH-B/ISH-B) or automatically with an electric actuator (QSH-E.../ISH-E...) or with a self powered thermal actuator (QSH-T/ISH-T).

The thermal actuator senses the supply air temperature. It contains a liquid which expands with heat and contracts with cold, thus adjusting the piston. An almost linear adjustment characteristic is achieved within the following range:
 Supply air temperature 15°C – horizontal discharge
 Supply air temperature 35°C – vertical discharge

Electrical wiring is not required for types QSH-T / ISH-T.

Materials

Galvanised perforated sheet steel cylinder, galvanised sheet steel spigot, air control disc and base plate.
 Galvanised surface finish is standard.

Optionally all visible surfaces can be powder-coated to a required RAL colour.

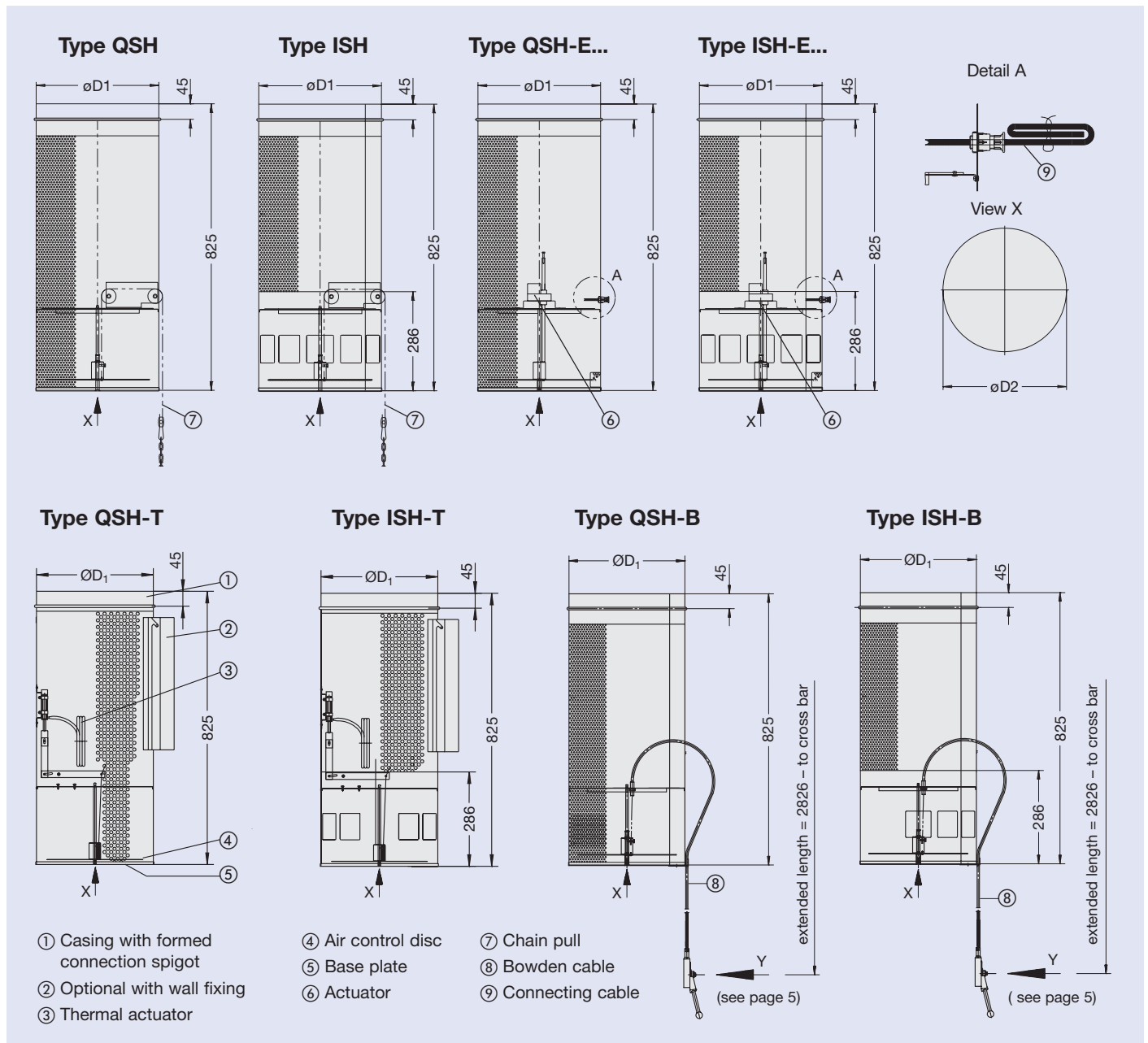

Installation

Dimensions in mm				
NW	250	355	450	560
ϕD_1	248	353	448	558
ϕD_2	252	357	452	562
AM	163	222	273	330
AZ	39	46	49	51

The units are installed directly into the system ducting and fixed by screws or rivets provided by others. The entire system must be securely fixed and suspended by appropriate means.

The units can be fitted to walls or columns using the wall brackets which can be supplied on request (W00).

The wall mounting frame is fixed by using bolts, after which the air displacement unit is located on the mounting frame from above and fitted to it using two screws.

In the case of the chain pull, the chain fixing bracket (K00) is plug fixed and the chain length altered to achieve the required position of the air control disc.

The hand lever of the Bowden cable variant has to be fixed to the wall or column at site.

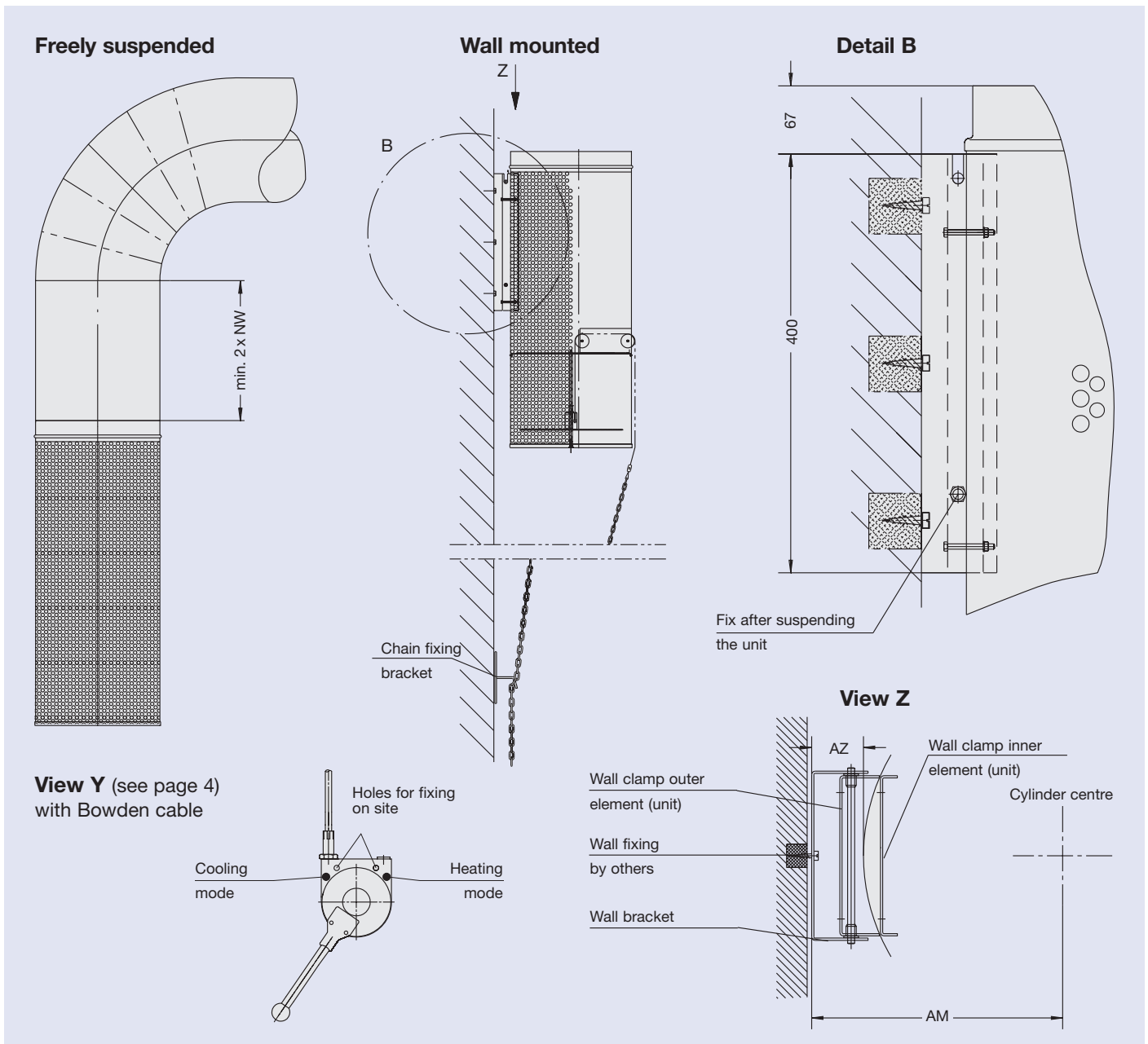

Nomenclature

\dot{V}	in l/s: Volume flow per unit
\dot{V}	in m ³ /h: Volume flow per unit
L_{\max}	in m: Maximum horizontal throw
Δt_z	in K: Supply air temperature differential
$H_{1\max}$	in m: Max. vertical penetration depth of jet in heating mode
\bar{v}_L	in m/s: Time average air velocity of 0.3 m/s
Δp_t	in Pa: Total pressure drop
L_{WA}	in dB(A): A-weighted sound power level

Type QSH

Below the unit air velocities in the occupied zone may deviate from the values required by DIN 1946/2 for comfort. Therefore, for example, installation above aisles is recommended.

Type ISH

Air velocities in the occupied zone correspond to the values required by DIN 1946/2 for comfort.

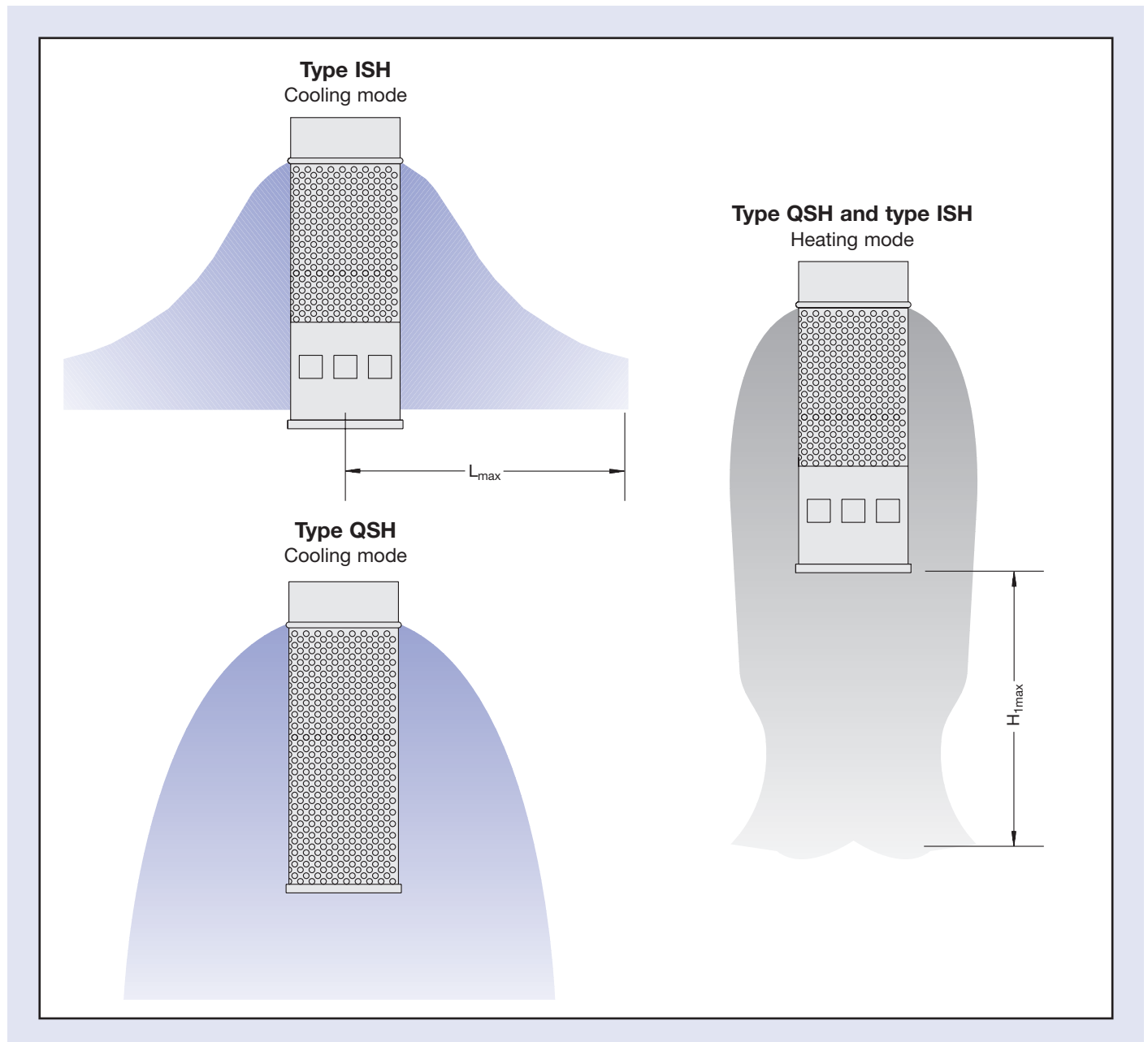

Maximum temperature differential

Heating mode (vertical): $\Delta t_{\max} = +12\text{ K}$

Cooling mode (horizontal): $\Delta t_{\max} = -8\text{ K}$

Recommended installation height above floor 3.5 m.

Sound power level and pressure drop, type QSH Correction for vertical discharge (heating mode), diagram 1				
Size	250	355	450	560
Δp_t	x 1.0	x 1.0	x 1.0	x 1.0
L_{WA}	+ 3	+ 4	+ 4	+ 4

Sound power level and pressure drop, type ISH Correction for vertical discharge (heating mode), diagram 2				
Size	250	355	450	560
Δp_t	x 1.0	x 1.0	x 1.0	x 1.0
L_{WA}	+ 3	+ 4	+ 8	+ 9

Example

Data given:

Type ISH, size 355

Volume flow

$\dot{V} = 2000\text{ m}^3/\text{h}$ (550 l/s)

Supply air temperature differential

$\Delta t_z = +12\text{ K}$

Acceptable air velocity

$\bar{v}_L = \text{approx. } 0.3\text{ m/s}$

Diagram 2: Sound power level and pressure drop
in cooling mode (horizontal) $L_{WA} = 48\text{ dB(A)}$
in heating mode (vertical) $L_{WA} = 48\text{ dB(A)} + 4\text{ dB(A)}$
(Correction from table)
 $L_{WA} = 52\text{ dB(A)}$
 $\Delta p_t = 32\text{ Pa}$

Diagram 3: Maximum jet penetration depth, vertical
discharge of warm air
 $\Delta t_z = +12\text{ K}$
 $H_{1\max} = 4.3\text{ m}$

Diagram 4: Horizontal throw at $\Delta t_z = -5\text{ K}$
and $\bar{v}_L = \text{approx. } 0.3\text{ m/s}$
 $L_{\max} = 3.15\text{ m}$

1 Type QSH
Sound power level and pressure drop (horizontal)

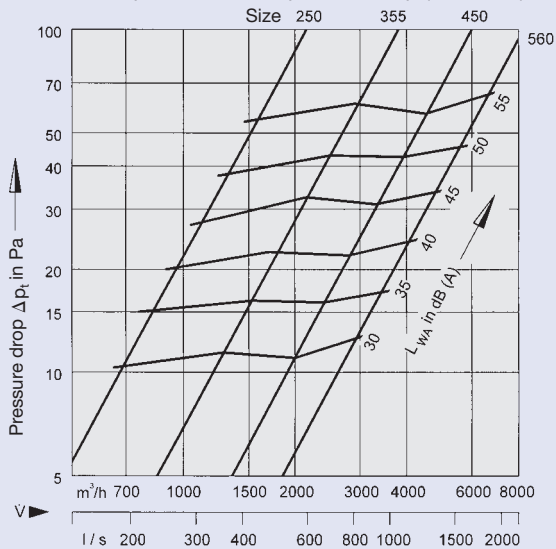

2 Type ISH
Sound power level and pressure drop (horizontal)

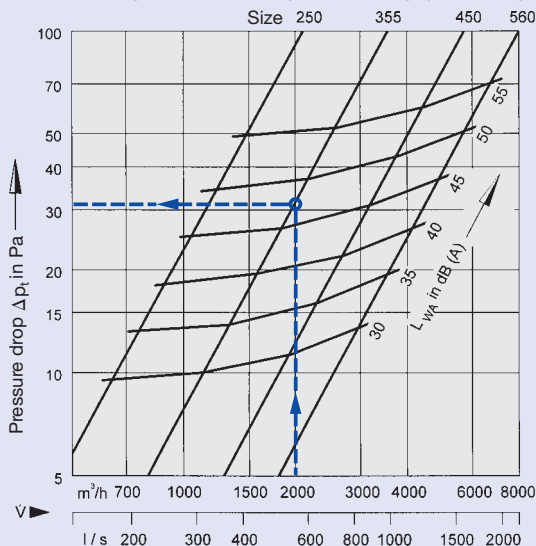

3 Type ISH · Type QSH
Maximum penetration depth vertical discharge in heating mode

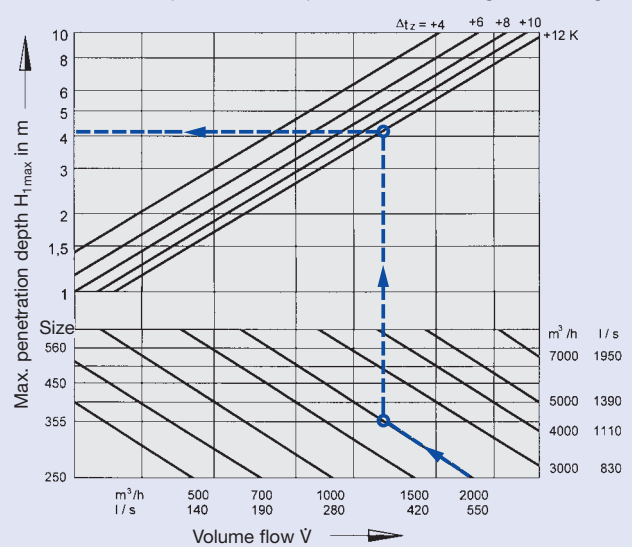

4 Type ISH
Horizontal throw at $\Delta t_z = -5\text{ K}$ and $\bar{v}_L = \text{approx. } 0.3\text{ m/s}$

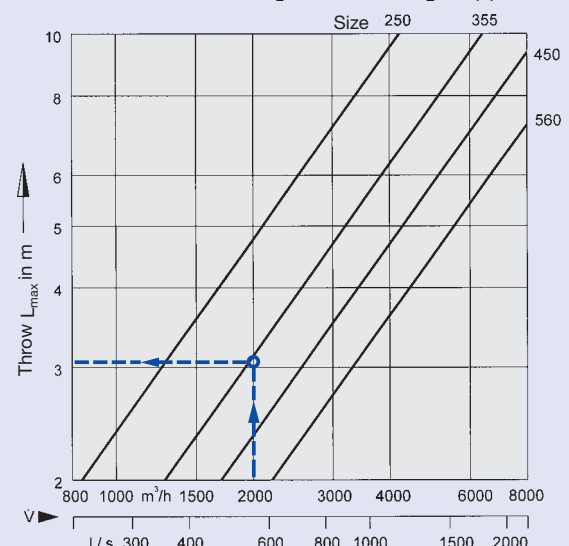

Order Details

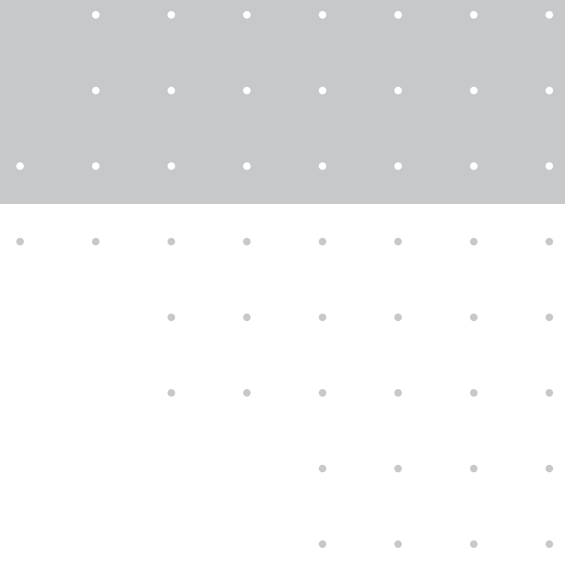

Order Code QSH · ISH

These codes do not need to be completed for standard products

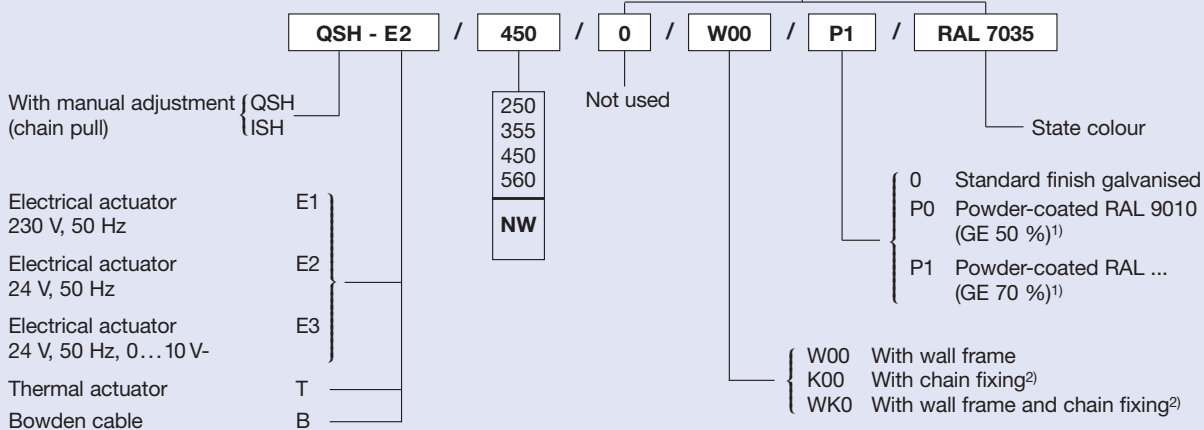

¹⁾ GE = Gloss level!
²⁾ for manual adjustment only

Specification Text

Air displacement vent unit in circular construction suitable for suspending above an occupied zone, primarily in large halls which require both heating and cooling functions.
 Type QSH for low-turbulence supply of fresh air without high air induction suitable for halls where there is a high degree of air pollution.
 Type ISH with additional openings, which generate a high momentum and therefore distribute the air over a larger area.

Adjustment:

- manually with chain pull (approx. 2 m) or Bowden cable (approx. 3 m)
- electrically with internally mounted actuator (e.g. with thermostat provided and installed by others)
- self-powered with internally mounted thermal actuator (operating automatically depending on supply air temperature differential).

Material:

The perforated plate cylinder with the air connection spigot, the air guide plate and the base plate are made of galvanised steel sheet.

All visible surfaces can be powder-coated to a RAL colour on request.

Order Example

Make: TROX
 Type: QSH - E2 / 450 / 0 / W00 / 0 / P1 / RAL 7035